







Design S

D100S

Fuel Type	Wood
Oven Type	Static

Wood ovens with Design S are basic one with metal cover and an arc facade finish – simple, elegant very durable where quality is viable. Those ovens are suitable both for inside kitchen use and building in option where only the oven face will be visible for customers. Currently no colour options are available.

Capacity	4  30cm
Productivity	60  per hour
Firewood Consumption 	3 – 4 kg per hour
Weight 	1100 kg



We are a company, specializing in the manufacture of professional ovens for pizzerias.

AS TERM L.T.D
144 Tsar Ivan Asen II
4230 Asenovgrad
Bulgaria

tel/fax +359 331 462 42
info@astermforni.com
www.astermforni.com

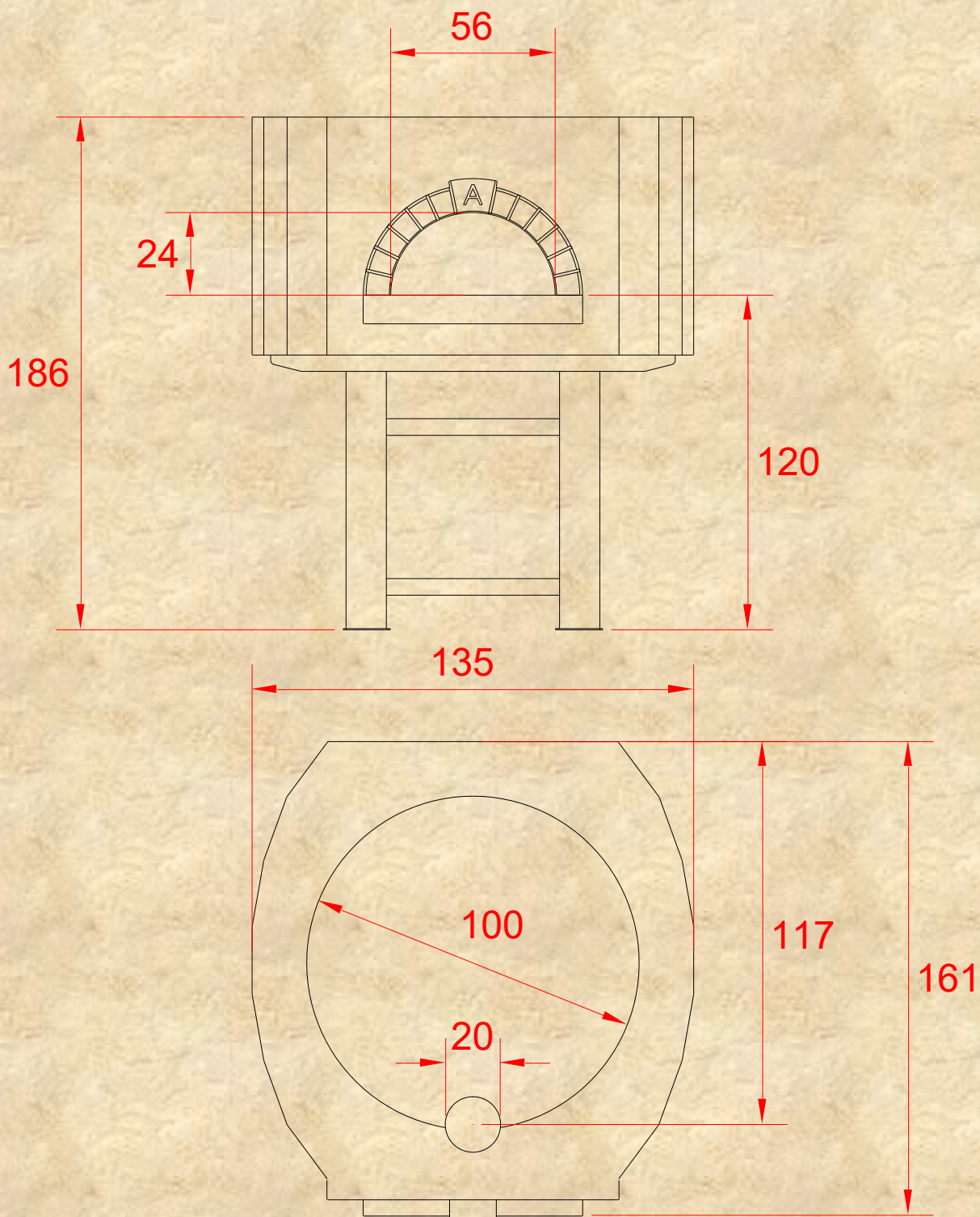

***Dimensions in cm**



We are a company, specializing in the manufacture of professional ovens for pizzerias.

AS TERM L.T.D
 144 Tsar Ivan Asen II
 4230 Asenovgrad
 Bulgaria

tel/fax +359 331 462 42
info@astermforni.com
www.astermforni.com