







MIX120V



Basic Design

Fuel Type	Wood & Gas
Oven Type	Static

Basic design mixed fuel (wood and gas) oven with static base. Simple and elegant design with brick façade, double door – one for the main baking chamber and additional door for the wood burning chamber. A separate drawer for the wood burning ashes and a gas burner with adjustable power. Classical and preferred mixed oven with very high durability – this is what this current oven offers.

Capacity	9  30 cm		Thermal Power	26 kW	
Productivity	135  per hour		Gas Connection	3/4"	
Firewood Consumption 	5 – 6 kg per hour		Gas Pressure	G30-31	G20
				37 mbar	20 mbar
Gas Consumption 	Natural Gas	LPG	Electrical Supply 	230V/50Hz	
	3.3 mc/h	1.9 kg/h		Weight 	1950 kg



We are a company, specializing in the manufacture of professional ovens for pizzerias.

AS TERM L.T.D
144 Tsar Ivan Asen II
4230 Asenovgrad
Bulgaria

tel/fax +359 331 462 42
info@astermforni.com
www.astermforni.com

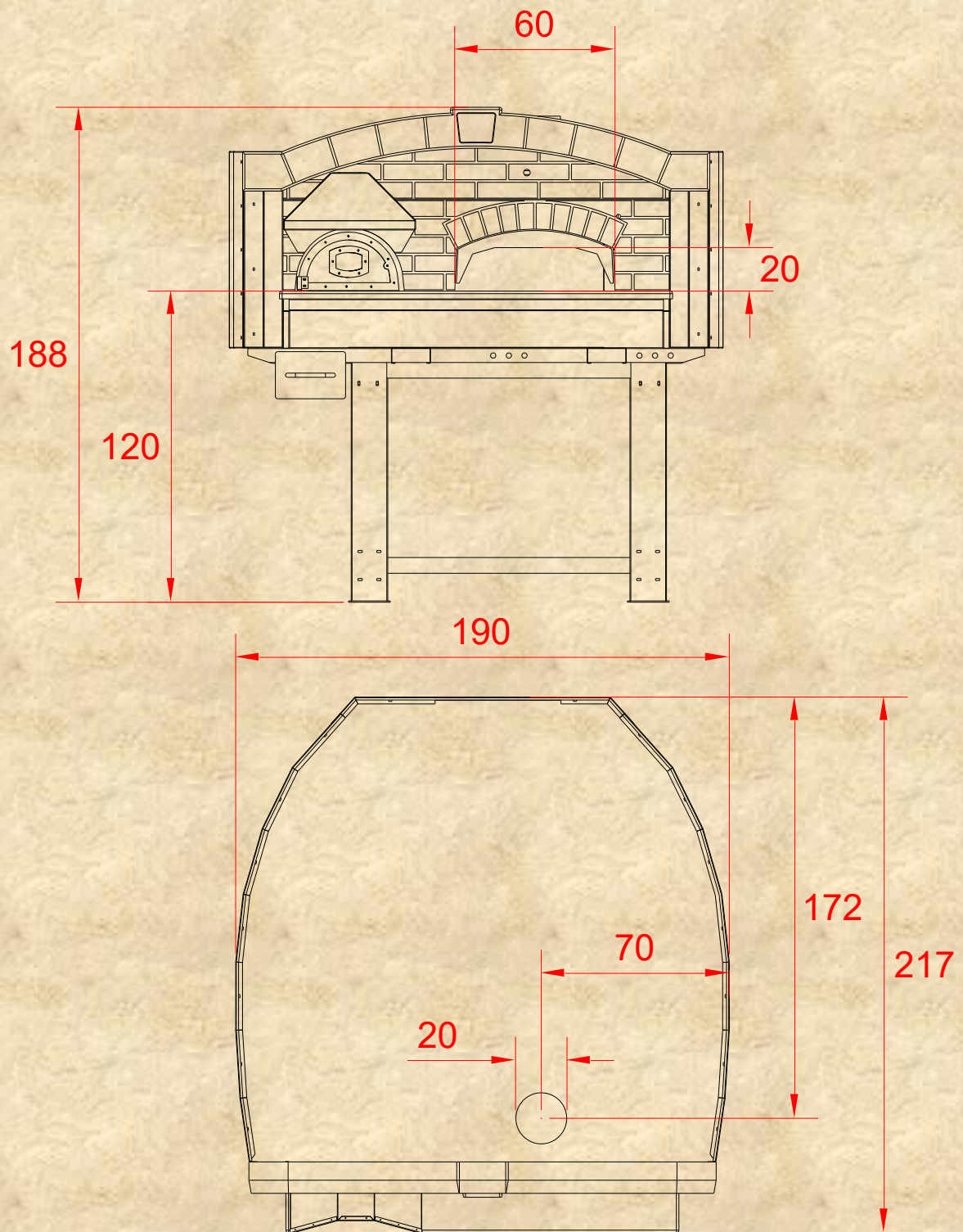

***Dimensions in cm**



We are a company, specializing in the manufacture of professional ovens for pizzerias.

AS TERM L.T.D
144 Tsar Ivan Asen II
4230 Asenovgrad
Bulgaria

tel/fax +359 331 462 42
info@astermforni.com
www.astermforni.com